



[Evaluation Kit Available](#)



[Design Resources](#)



[Tools and Models](#)



[Support](#)

Click [here](#) to ask an associate for production status of specific part numbers.

Four-Channel, Fast, Low-Power, 3kV_{RMS} and 3.75kV_{RMS} Digital Isolators

MAX14430–MAX14432

General Description

The MAX14430/MAX14431/MAX14432 are fast, low power, 4-channel, digital galvanic isolators using Maxim's proprietary process technology. These devices transfer digital signals between circuits with different power domains while using as little as 0.58mW per channel at 1Mbps with a 1.8V supply. The MAX14430–MAX14432 have an isolation rating of 3kV_{RMS} (QSOP package) or 3.75kV_{RMS} (narrow SOIC package) for 60 seconds. For applications requiring 5kV_{RMS} of isolation, see the MAX14434-MAX14436.

The MAX14430-MAX14432 family offers all three possible unidirectional channel configurations and active high and low output enable options to accommodate any 4-channel design, including SP -RS-232, RS-485 and digital I/O applications.

Devices are available with a maximum data rate of either 25Mbps or 200Mbps and with outputs that are either default-high or default-low. The default is the state the output assumes when the input is either not powered or is open-circuit. See the [Ordering Information](#) and [Product Selector Guide](#) for suffixes associated with each option. Independent 1.71V to 5.5V supplies on each side of the isolator also make the devices suitable for use as level translators.

The MAX14430–MAX14432 are available either in a 16-pin narrow-body SOIC package with 4mm of creepage and clearance, or in a smaller 16-pin QSOP package with 4mm of creepage and clearance. The SOIC package material has a minimum comparative tracking index (CTI) of 600, which gives it a group I rating in creepage table. The QSOP package material has a minimum CTI of 400, which gives it a group II rating in creepage table. All devices are rated for operation at ambient temperatures of -40°C to +125°C.

Benefits and Features

- Robust Galvanic Isolation for Fast Digital Signals
 - Up to 200Mbps Data Rate
 - Continuously Withstands 445V_{RMS} (V_{IOWM})
 - Withstands 3.75kV_{RMS} for 60s (V_{ISO}) Narrow SOIC Package
 - Withstands 3kV_{RMS} for 60s (V_{ISO}) QSOP Package
 - Withstands ±10kV Surge between GNDA and GNDB with 1.2/50µs Waveform Narrow SOIC Package
 - Withstands ±7.5kV Surge between GNDA and GNDB with 1.2/50µs Waveform QSOP Package
 - High CMTI (50kV/µs, Typical)
- Low Power Consumption
 - 1.1mW per Channel at 1Mbps with V_{DD} = 3.3V
 - 3.5mW per Channel at 100Mbps with V_{DD} = 1.8V
- Options to Support a Broad Range of Applications
 - 2 Data Rates (25Mbps, 200Mbps)
 - 3 Channel Direction Configurations
 - 2 Output Default States (High/Low)
 - Two Packages (Narrow SOIC and QSOP)

Applications

- Isolated SPI Interface
- Fieldbus Communications for Industrial Automation
- Isolated RS-485/RS-422, CAN
- Battery Management
- Medical Systems

Safety Regulatory Approvals

- UL According to UL1577
- cUL According to CSA Bulletin 5A

[Ordering Information](#) and [Product Selector Guide](#) appear at end of data sheet.

Absolute Maximum Ratings

V _{DDA} to GNDA.....	-0.3V to +6V	Continuous Power Dissipation (T _A = +70°C) Narrow SOIC (derate 13.3mW/°C above +70°C) 1066.7mW QSOP (derate 9.6mW/°C above +70°C)..... 771.5mW Operating Temperature Range..... -40°C to +125°C Maximum Junction Temperature +150°C Storage Temperature Range..... -60°C to +150°C Soldering Temperature (reflow) +260°C
V _{DDB} to GNDB.....	-0.3V to +6V	
IN_, EN_ on Side A to GNDA.....	-0.3V to +6V	
IN_, EN_ on Side B to GNDB.....	-0.3V to +6V	
OUT_ on Side A to GNDA.....	-0.3V to (V _{DDA} + 0.3V)	
OUT_ on Side B to GNDB.....	-0.3V to (V _{DDB} + 0.3V)	
Short-Circuit Duration		
OUT_ on Side A to GNDA,		
OUT_ on Side B to GNDB.....	Continuous	

Stresses beyond those listed under "Absolute Maximum Ratings" may cause permanent damage to the device. These are stress ratings only, and functional operation of the device at these or any other conditions beyond those indicated in the operational sections of the specifications is not implied. Exposure to absolute maximum rating conditions for extended periods may affect device reliability.

Package Information

PACKAGE TYPE: 16 NARROW SOIC	
Package Code	S16MS+12
Outline Number	21-0041
Land Pattern Number	90-0442
THERMAL RESISTANCE, FOUR-LAYER BOARD	
Junction to Ambient (θ _{JA})	75°C/W
Junction to Case (θ _{JC})	24°C/W

PACKAGE TYPE: 16 QSOP	
Package Code	E16MS+1F
Outline Number	21-0055
Land Pattern Number	90-0167
THERMAL RESISTANCE, FOUR-LAYER BOARD	
Junction to Ambient (θ _{JA})	103.7°C/W
Junction to Case (θ _{JC})	37°C/W

For the latest package outline information and land patterns (footprints), go to www.analog.com/packages. Note that a "+", "#", or "-" in the package code indicates RoHS status only. Package drawings may show a different suffix character, but the drawing pertains to the package regardless of RoHS status.

Package thermal resistances were obtained using the method described in JEDEC specification JESD51-7, using a four-layer board. For detailed information on package thermal considerations, refer to www.analog.com/thermal-tutorial.

DC Electrical Characteristics

(V_{DDA} - V_{GNDA} = 1.71V to 5.5V, V_{DDB} - V_{GNDB} = 1.71V to 5.5V, C_L = 15pF, T_A = -40°C to +125°C, unless otherwise noted. Typical values are at V_{DDA} - V_{GNDA} = 3.3V, V_{DDB} - V_{GNDB} = 3.3V, V_{GNDA} = V_{GNDB}, T_A = +25°C, unless otherwise noted.) (Note 1)

PARAMETER	SYMBOL	CONDITIONS		MIN	TYP	MAX	UNITS
POWER SUPPLY							
Supply Voltage	V _{DDA}	Relative to GNDA		1.71		5.5	V
	V _{DDB}	Relative to GNDB		1.71		5.5	
Undervoltage-Lockout Threshold	V _{UVLO_}	V _{DD_} rising		1.5	1.6	1.66	V
Undervoltage-Lockout Threshold Hysteresis	V _{UVLO_HYST}				45		mV
Supply Current (MAX14430_) (Note 2)	I _{DDA}	500kHz square wave, C _L = 0pF	V _{DDA} = 5V		0.52	0.96	mA
			V _{DDA} = 3.3V		0.51	0.93	
			V _{DDA} = 2.5V		0.50	0.92	
			V _{DDA} = 1.8V		0.49	0.64	
		12.5MHz square wave, C _L = 0pF	V _{DDA} = 5V		1.63	2.42	
			V _{DDA} = 3.3V		1.59	2.36	
			V _{DDA} = 2.5V		1.58	2.33	
		50MHz square wave, C _L = 0pF	V _{DDA} = 1.8V		1.54	2.00	
			V _{DDA} = 5V		4.5	6.14	
			V _{DDA} = 3.3V		4.39	6.00	
			V _{DDA} = 2.5V		4.35	5.93	
		Supply Current (MAX14430_) (Note 2)	I _{DDB}	500kHz square wave, C _L = 0pF	V _{DDB} = 5V		
V _{DDB} = 3.3V					0.82	1.41	
V _{DDB} = 2.5V					0.81	1.39	
V _{DDB} = 1.8V					0.79	1.32	
12.5MHz square wave, C _L = 0pF	V _{DDB} = 5V				2.97	3.84	
	V _{DDB} = 3.3V				2.00	2.74	
	V _{DDB} = 2.5V				1.69	2.36	
50MHz square wave, C _L = 0pF	V _{DDB} = 1.8V				1.43	2.02	
	V _{DDB} = 5V				9.52	11.17	
	V _{DDB} = 3.3V				5.68	6.88	
	V _{DDB} = 2.5V				4.45	5.38	
				V _{DDB} = 1.8V		3.46	4.18

DC Electrical Characteristics (continued)

(V_{DDA} - V_{GNDA} = 1.71V to 5.5V, V_{DDB} - V_{GNDB} = 1.71V to 5.5V, C_L = 15pF, T_A = -40°C to +125°C, unless otherwise noted. Typical values are at V_{DDA} - V_{GNDA} = 3.3V, V_{DDB} - V_{GNDB} = 3.3V, V_{GNDA} = V_{GNDB}, T_A = +25°C, unless otherwise noted.) (Note 1)

PARAMETER	SYMBOL	CONDITIONS		MIN	TYP	MAX	UNITS
Supply Current (MAX14431_) (Note 2)	I _{DDA}	500kHz square wave, C _L = 0pF	V _{DDA} = 5V	0.62	1.10	mA	
			V _{DDA} = 3.3V	0.60	1.06		
			V _{DDA} = 2.5V	0.59	1.05		
			V _{DDA} = 1.8V	0.57	0.83		
		12.5MHz square wave, C _L = 0pF	V _{DDA} = 5V	1.98	2.80		
			V _{DDA} = 3.3V	1.70	2.47		
			V _{DDA} = 2.5V	1.61	2.35		
			V _{DDA} = 1.8V	1.52	2.02		
		50MHz square wave, C _L = 0pF	V _{DDA} = 5V	5.77	7.43		
			V _{DDA} = 3.3V	4.73	6.25		
			V _{DDA} = 2.5V	4.38	5.81		
			V _{DDA} = 1.8V	4.03	5.15		
	I _{DDB}	500kHz square wave, C _L = 0pF	V _{DDB} = 5V	0.78	1.35	mA	
			V _{DDB} = 3.3V	0.75	1.30		
			V _{DDB} = 2.5V	0.74	1.28		
			V _{DDB} = 1.8V	0.72	1.16		
		12.5MHz square wave, C _L = 0pF	V _{DDB} = 5V	2.64	3.49		
			V _{DDB} = 3.3V	1.90	2.65		
			V _{DDB} = 2.5V	1.66	2.36		
			V _{DDB} = 1.8V	1.46	2.03		
		50MHz square wave, C _L = 0pF	V _{DDB} = 5V	8.26	9.91		
			V _{DDB} = 3.3V	5.36	6.66		
			V _{DDB} = 2.5V	4.42	5.52		
			V _{DDB} = 1.8V	3.66	4.51		

DC Electrical Characteristics (continued)

(V_{DDA} - V_{GNDA} = 1.71V to 5.5V, V_{DDB} - V_{GNDB} = 1.71V to 5.5V, C_L = 15pF, T_A = -40°C to +125°C, unless otherwise noted. Typical values are at V_{DDA} - V_{GNDA} = 3.3V, V_{DDB} - V_{GNDB} = 3.3V, V_{GNDA} = V_{GNDB}, T_A = +25°C, unless otherwise noted.) (Note 1)

PARAMETER	SYMBOL	CONDITIONS	MIN	TYP	MAX	UNITS
Supply Current (MAX14432_) (Note 2)	I _{DDA}	500kHz square wave, C _L = 0pF	V _{DDA} = 5V	0.70	1.22	mA
			V _{DDA} = 3.3V	0.67	1.17	
			V _{DDA} = 2.5V	0.66	1.16	
			V _{DDA} = 1.8V	0.64	0.99	
		12.5MHz square wave, C _L = 0pF	V _{DDA} = 5V	2.31	3.15	
			V _{DDA} = 3.3V	1.81	2.56	
			V _{DDA} = 2.5V	1.64	2.35	
			V _{DDA} = 1.8V	1.50	2.02	
		50MHz square wave, C _L = 0pF	V _{DDA} = 5V	7.04	8.70	
			V _{DDA} = 3.3V	5.06	6.46	
			V _{DDA} = 2.5V	4.40	5.67	
			V _{DDA} = 1.8V	3.85	4.83	
	I _{DDB}	500kHz square wave, C _L = 0pF	V _{DDB} = 5V	0.70	1.24	mA
			V _{DDB} = 3.3V	0.67	1.19	
			V _{DDB} = 2.5V	0.66	1.17	
			V _{DDB} = 1.8V	0.65	1.00	
		12.5MHz square wave, C _L = 0pF	V _{DDB} = 5V	2.31	3.15	
			V _{DDB} = 3.3V	1.80	2.57	
			V _{DDB} = 2.5V	1.64	2.36	
			V _{DDB} = 1.8V	1.49	2.03	
		50MHz square wave, C _L = 0pF	V _{DDB} = 5V	7.01	8.66	
			V _{DDB} = 3.3V	5.04	6.46	
			V _{DDB} = 2.5V	4.40	5.67	
			V _{DDB} = 1.8V	3.84	4.83	

DC Electrical Characteristics (continued)

(V_{DDA} - V_{GNDA} = 1.71V to 5.5V, V_{DDB} - V_{GNDB} = 1.71V to 5.5V, C_L = 15pF, T_A = -40°C to +125°C, unless otherwise noted. Typical values are at V_{DDA} - V_{GNDA} = 3.3V, V_{DDB} - V_{GNDB} = 3.3V, V_{GNDA} = V_{GNDB}, T_A = +25°C, unless otherwise noted.) (Note 1)

PARAMETER	SYMBOL	CONDITIONS	MIN	TYP	MAX	UNITS	
LOGIC INPUTS AND OUTPUTS							
Input High Voltage	V _{IH}	EN __ , IN __ , relative to GND __	2.25V ≤ V _{DD__} ≤ 5.5V	0.7 x V _{DD__}		V	
		EN __ , IN __ , relative to GND __	1.71V ≤ V _{DD__} < 2.25V	0.75 x V _{DD__}			
Input Low Voltage	V _{IL}	EN __ , IN __ , relative to GND __	2.25V ≤ V _{DD__} ≤ 5.5V	0.8		V	
		EN __ , IN __ , relative to GND __	1.71V ≤ V _{DD__} < 2.25V	0.7			
Input Hysteresis	V _{HYS}	EN __ , IN __ , relative to GND __	MAX1443_B/E	410		mV	
		EN __ , IN __ , relative to GND __	MAX1443_C/F	80			
Input Pullup Current (Note 3)	I _{PU}	IN __ , MAX1443_B/C		-10	-5	-1.5	μA
Input Pulldown Current (Note 3)	I _{PD}	IN __ , MAX1443_E/F		1.5	5	10	μA
EN Pullup Current (Note 3)	I _{PU_EN}	EN __		-10	-5	-1.5	μA
Input Capacitance	C _{IN}	IN __ , f _{SW} = 1MHz		2		pF	
Output Voltage High (Note 3)	V _{OH}	V _{OUT__} relative to GND __ I _{OUT__} = -4mA source		V _{DD__} - 0.4		V	
Output Voltage Low (Note 3)	V _{OL}	V _{OUT__} relative to GND __ I _{OUT__} = 4mA sink		0.4		V	

Dynamic Characteristics MAX1443_C/F

(V_{DDA} - V_{GNDA} = 1.71V to 5.5V, V_{DDB} - V_{GNDB} = 1.71V to 5.5V, C_L = 15pF, T_A = -40°C to +125°C, unless otherwise noted. Typical values are at V_{DDA} - V_{GNDA} = 3.3V, V_{DDB} - V_{GNDB} = 3.3V, V_{GNDA} = V_{GNDB}, T_A = +25°C, unless otherwise noted.) (Note 2)

PARAMETER	SYMBOL	CONDITIONS	MIN	TYP	MAX	UNITS	
Common-Mode Transient Immunity	CMTI	IN ₋ = GND ₋ or V _{DD-} (Note 4)		50		kV/μs	
Maximum Data Rate	DR _{MAX}	2.25V ≤ V _{DD-} ≤ 5.5V	200			Mbps	
		1.71V ≤ V _{DD-} < 2.25V	150				
Minimum Pulse Width	PW _{MIN}	IN ₋ to OUT ₋	2.25V ≤ V _{DD-} ≤ 5.5V		5	ns	
			1.71V ≤ V _{DD-} ≤ 1.89V		6.67		
Propagation Delay (Figure 1)	t _{PLH}	IN ₋ to OUT ₋ , C _L = 15pF	4.5V ≤ V _{DD-} ≤ 5.5V	4.1	5.4	9.2	ns
			3.0V ≤ V _{DD-} ≤ 3.6V	4.2	5.9	10.2	
			2.25V ≤ V _{DD-} ≤ 2.75V	4.9	7.1	13.4	
			1.71V ≤ V _{DD-} ≤ 1.89V	7.1	10.9	20.3	
	t _{PHL}	IN ₋ to OUT ₋ , C _L = 15pF	4.5V ≤ V _{DD-} ≤ 5.5V	4.3	5.6	9.4	
			3.0V ≤ V _{DD-} ≤ 3.6V	4.4	6.2	10.5	
			2.25V ≤ V _{DD-} ≤ 2.75V	5.1	7.3	14.1	
			1.71V ≤ V _{DD-} ≤ 1.89V	7.2	10.9	21.7	
Pulse Width Distortion	PWD	t _{PLH} - t _{PHL}		0.3	2	ns	
Propagation Delay Skew Part-to-Part (Same Channel)	t _{SPLH}		4.5V ≤ V _{DD-} ≤ 5.5V		3.7	ns	
			3.0V ≤ V _{DD-} ≤ 3.6V		4.3		
			2.25V ≤ V _{DD-} ≤ 2.75V		6		
			1.71V ≤ V _{DD-} ≤ 1.89V		10.3		
	t _{SPHL}		4.5V ≤ V _{DD-} ≤ 5.5V		3.8		
			3.0V ≤ V _{DD-} ≤ 3.6V		4.7		
			2.25V ≤ V _{DD-} ≤ 2.75V		6.5		
			1.71V ≤ V _{DD-} ≤ 1.89V		11.5		
Propagation Delay Skew Channel-to-Channel (Same Direction)	t _{SCSLH}	1.71V ≤ V _{DD-} ≤ 5.5V		1.5	ns		
	t _{SCSHL}	1.71V ≤ V _{DD-} ≤ 5.5V		1.5			

Dynamic Characteristics MAX1443_C/F (continued)

(V_{DDA} - V_{GNDA} = 1.71V to 5.5V, V_{DDB} - V_{GNDB} = 1.71V to 5.5V, C_L = 15pF, T_A = -40°C to +125°C, unless otherwise noted. Typical values are at V_{DDA} - V_{GNDA} = 3.3V, V_{DDB} - V_{GNDB} = 3.3V, V_{GNDA} = V_{GNDB}, T_A = +25°C, unless otherwise noted.) (Note 2)

PARAMETER	SYMBOL	CONDITIONS	MIN	TYP	MAX	UNITS
Propagation Delay Skew Channel-to-Channel (Opposite Direction)	t _{SCOLH}	4.5V ≤ V _{DD_} ≤ 5.5V			2.9	ns
		3.0V ≤ V _{DD_} ≤ 3.6V			3.4	
		2.25V ≤ V _{DD_} ≤ 2.75V			4.9	
		1.71V ≤ V _{DD_} ≤ 1.89V			10.2	
	t _{SCOHL}	4.5V ≤ V _{DD_} ≤ 5.5V			3.2	
		3.0V ≤ V _{DD_} ≤ 3.6V			3.8	
		2.25V ≤ V _{DD_} ≤ 2.75V			5.3	
		1.71V ≤ V _{DD_} ≤ 1.89V			10.9	
Peak Eye Diagram Jitter	T _{JIT(PK)}	200Mbps		90		ps
Clock Jitter RMS	T _{JCLK(RMS)}	500kHz Clock Input, Rising/Falling Edges		6.5		ps
Rise Time (Figure 1)	t _R	4.5V ≤ V _{DD_} ≤ 5.5V			1.6	ns
		3.0V ≤ V _{DD_} ≤ 3.6V			2.2	
		2.25V ≤ V _{DD_} ≤ 2.75V			3	
		1.71V ≤ V _{DD_} ≤ 1.89V			4.5	
Fall Time (Figure 1)	t _F	4.5V ≤ V _{DD_} ≤ 5.5V			1.4	ns
		3.0V ≤ V _{DD_} ≤ 3.6V			2	
		2.25V ≤ V _{DD_} ≤ 2.75V			2.8	
		1.71V ≤ V _{DD_} ≤ 1.89V			5.1	
Enable to Data Valid	t _{EN}	ENA to OUT_ ₁ , ENB to OUT_ ₁ , C _L = 15pF	4.5V ≤ V _{DD_} ≤ 5.5V		3.5	ns
		3.0V ≤ V _{DD_} ≤ 3.6V		5.8		
		2.25V ≤ V _{DD_} ≤ 2.75V		9.3		
		1.71V ≤ V _{DD_} ≤ 1.89V		17.4		
Enable to Tristate	t _{TRI}	ENA to OUT_ ₁ , ENB to OUT_ ₁ , C _L = 15pF	4.5V ≤ V _{DD_} ≤ 5.5V		6.4	ns
		3.0V ≤ V _{DD_} ≤ 3.6V		9.2		
		2.25V ≤ V _{DD_} ≤ 2.75V		12.8		
		1.71V ≤ V _{DD_} ≤ 1.89V		19.4		

Dynamic Characteristics MAX1443_B/E

(V_{DDA} - V_{GNDA} = 1.71V to 5.5V, V_{DDB} - V_{GNDB} = 1.71V to 5.5V, C_L = 15pF, T_A = -40°C to +125°C, unless otherwise noted. Typical values are at V_{DDA} - V_{GNDA} = 3.3V, V_{DDB} - V_{GNDB} = 3.3V, V_{GNDA} = V_{GNDB}, T_A = +25°C, unless otherwise noted.) (Note 2)

PARAMETER	SYMBOL	CONDITIONS	MIN	TYP	MAX	UNITS	
Common-Mode Transient Immunity	CMTI	IN_ = GND_ or V _{DD_} (Note 4)		50		kV/μs	
Maximum Data Rate	DR _{MAX}		25			Mbps	
Minimum Pulse Width	PW _{MIN}	IN_ to OUT_			40	ns	
Glitch Rejection		IN_ to OUT_	10	17	29	ns	
Propagation Delay (Figure 1)	t _{PLH}	IN_ to OUT_, C _L = 15pF	4.5V ≤ V _{DD_} ≤ 5.5V	17.4	23.9	32.5	ns
			3.0V ≤ V _{DD_} ≤ 3.6V	17.6	24.4	33.7	
			2.25V ≤ V _{DD_} ≤ 2.75V	18.3	25.8	36.7	
			1.71V ≤ V _{DD_} ≤ 1.89V	20.7	29.6	43.5	
	t _{PHL}	IN_ to OUT_, C _L = 15pF	4.5V ≤ V _{DD_} ≤ 5.5V	16.9	23.4	33.6	
			3.0V ≤ V _{DD_} ≤ 3.6V	17.2	24.2	35.1	
			2.25V ≤ V _{DD_} ≤ 2.75V	17.8	25.4	38.2	
			1.71V ≤ V _{DD_} ≤ 1.89V	19.8	29.3	45.8	
Pulse Width Distortion	PWD	t _{PLH} - t _{PHL}		0.4	4	ns	
Propagation Delay Skew Part-to-Part (Same Channel)	t _{SPLH}		4.5V ≤ V _{DD_} ≤ 5.5V			15.1	ns
			3.0V ≤ V _{DD_} ≤ 3.6V			15	
			2.25V ≤ V _{DD_} ≤ 2.75V			15.4	
			1.71V ≤ V _{DD_} ≤ 1.89V			20.5	
	t _{SPHL}		4.5V ≤ V _{DD_} ≤ 5.5V			13.9	
			3.0V ≤ V _{DD_} ≤ 3.6V			14.2	
			2.25V ≤ V _{DD_} ≤ 2.75V			16	
			1.71V ≤ V _{DD_} ≤ 1.89V			21.8	
Propagation Delay Skew Channel-to-Channel (Same Direction)	t _{SCSLH}	1.71V ≤ V _{DD_} ≤ 5.5V			2	ns	
	t _{SCSHL}	1.71V ≤ V _{DD_} ≤ 5.5V			2		
Propagation Delay Skew Channel-to-Channel (Opposite Direction)	t _{SCOLH}		4.5V ≤ V _{DD_} ≤ 5.5V			13.9	ns
			3.0V ≤ V _{DD_} ≤ 3.6V			13.7	
			2.25V ≤ V _{DD_} ≤ 2.75V			14.2	
			1.71V ≤ V _{DD_} ≤ 1.89V			19.4	
	t _{SCOHL}		4.5V ≤ V _{DD_} ≤ 5.5V			13	
			3.0V ≤ V _{DD_} ≤ 3.6V			12.9	
			2.25V ≤ V _{DD_} ≤ 2.75V			14.4	
			1.71V ≤ V _{DD_} ≤ 1.89V			20.1	
Fail-Safe Delay	t _{FS}	Fail-safe delay time from input data or power loss to output		50		μs	

Dynamic Characteristics MAX1443_B/E (continued)

(V_{DDA} - V_{GNDA} = 1.71V to 5.5V, V_{DDB} - V_{GNDB} = 1.71V to 5.5V, C_L = 15pF, T_A = -40°C to +125°C, unless otherwise noted. Typical values are at V_{DDA} - V_{GNDA} = 3.3V, V_{DDB} - V_{GNDB} = 3.3V, V_{GNDA} = V_{GNDB}, T_A = +25°C, unless otherwise noted.) (Note 2)

PARAMETER	SYMBOL	CONDITIONS	MIN	TYP	MAX	UNITS
Peak Eye Diagram Jitter	T _{JIT(PK)}	25Mbps		250		ps
Rise Time (Figure 1)	t _R	4.5V ≤ V _{DD_} ≤ 5.5V			1.6	ns
		3.0V ≤ V _{DD_} ≤ 3.6V			2.2	
		2.25V ≤ V _{DD_} ≤ 2.75V			3	
		1.71V ≤ V _{DD_} ≤ 1.89V			4.5	
Fall Time (Figure 1)	t _F	4.5V ≤ V _{DD_} ≤ 5.5V			1.4	ns
		3.0V ≤ V _{DD_} ≤ 3.6V			2	
		2.25V ≤ V _{DD_} ≤ 2.75V			2.8	
		1.71V ≤ V _{DD_} ≤ 1.89V			5.1	
Enable to Data Valid	t _{EN}	ENA to OUT_ ₋ , ENB to OUT_ ₋ , C _L = 15pF	4.5V ≤ V _{DD_} ≤ 5.5V		3.5	ns
			3.0V ≤ V _{DD_} ≤ 3.6V		5.8	
			2.25V ≤ V _{DD_} ≤ 2.75V		9.3	
			1.71V ≤ V _{DD_} ≤ 1.89V		17.4	
Enable to Tristate	t _{TRI}	ENA to OUT_ ₋ , ENB to OUT_ ₋ , C _L = 15pF	4.5V ≤ V _{DD_} ≤ 5.5V		6.4	ns
			3.0V ≤ V _{DD_} ≤ 3.6V		9.2	
			2.25V ≤ V _{DD_} ≤ 2.75V		12.8	
			1.71V ≤ V _{DD_} ≤ 1.89V		19.4	

Note 1: All devices are 100% production tested at T_A = +25°C. Specifications over temperature are guaranteed by design and characterization.

Note 2: Not production tested. Guaranteed by design and characterization.

Note 3: All currents into the device are positive. All currents out of the device are negative. All voltages are referenced to their respective ground (GNDA or GNDB), unless otherwise noted.

Note 4: CMTI is the maximum sustainable common-mode voltage slew rate while maintaining the correct output. CMTI applies to both rising and falling common-mode voltage edges. Tested with the transient generator connected between GNDA and GNDB (V_{CM} = 1000V).

MAX14430–MAX14432

Four-Channel, Fast, Low-Power, 3kV_{RMS} and 3.75kV_{RMS} Digital Isolators

ESD Protection

PARAMETER	SYMBOL	CONDITIONS	MIN	TYP	MAX	UNITS
ESD		Human Body Model, All Pins		±4		kV

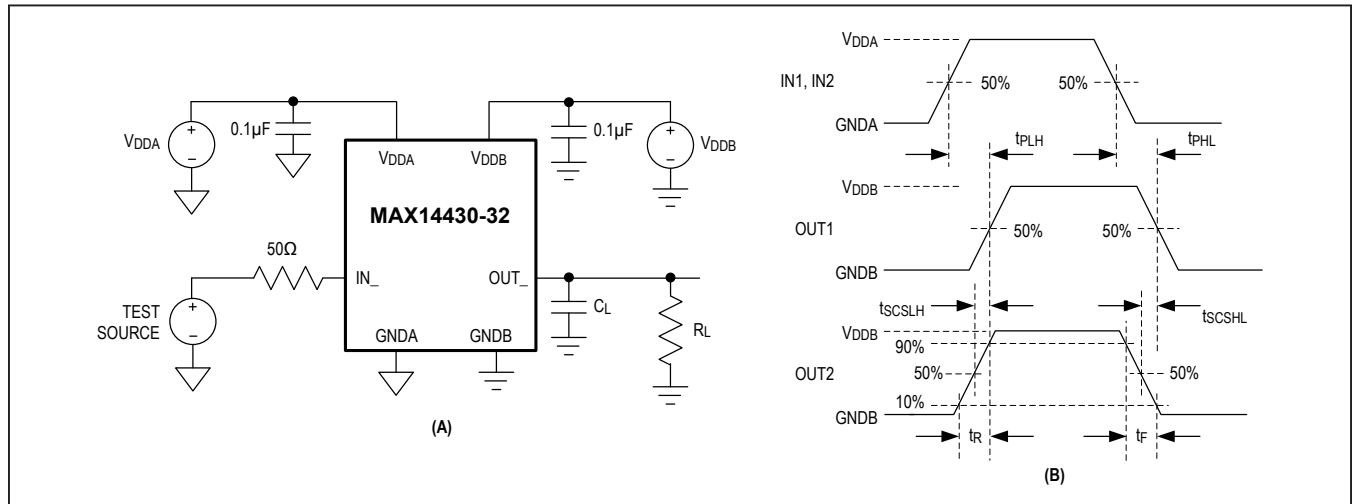

Figure 1. Test Circuit (A) and Timing Diagram (B)

Safety Regulatory Approvals

UL
The MAX14430–MAX14432 are certified under UL1577. For more details, refer to File E351759.
Devices in narrow SOIC package are rated up to 3750V _{RMS} isolation voltage for single protection.
Devices in QSOP package are rated up to 3000V _{RMS} isolation voltage for single protection.
cUL (Equivalent to CSA notice 5A)
The MAX14430–MAX14432 are certified up to 3750V _{RMS} (narrow SOIC package) or 3000V _{RMS} (QSOP package) for single protection. For more details, refer to File E351759.

Table 1. Narrow SOIC Insulation Characteristics

PARAMETER	SYMBOL	CONDITIONS	VALUE	UNITS
Partial Discharge Test Voltage	V _{PR}	Method B1 = V _{IORM} × 1.875 (t = 1s, partial discharge < 5pC)	1182	V _P
Maximum Repetitive Peak Isolation Voltage	V _{IORM}	(Note 5)	630	V _P
Maximum Working Isolation Voltage	V _{IOWM}	Continuous RMS voltage (Note 5)	445	V _{RMS}
Maximum Transient Isolation Voltage	V _{IOTM}	t = 1s (Note 5)	6000	V _P
Maximum Withstand Isolation Voltage	V _{ISO}	f _{SW} = 60Hz, duration = 60s (Note 5, 6)	3750	V _{RMS}
Maximum Surge Isolation Voltage	V _{IOSM}	Basic Insulation, 1.2/50µs pulse per IEC 61000-4-5 (Note 5, 7)	10	kV
Insulation Resistance	R _{IO}	V _{IO} = 500V, T _A = 25°C	> 10 ¹²	Ω
		V _{IO} = 500V, 100°C ≤ T _A ≤ 125°C	> 10 ¹¹	
		V _{IO} = 500V at T _A = 150°C	> 10 ⁹	
Barrier Capacitance Side A to Side B	C _{IO}	f _{SW} = 1MHz (Note 8)	2	pF
Minimum Creepage Distance	CPG	Narrow SOIC	4	mm
Minimum Clearance Distance	CLR	Narrow SOIC	4	mm
Internal Clearance		Distance through insulation	0.015	mm
Comparative Tracking Index	CTI	Material Group I (IEC 60112)	> 600	
Climate Category			40/125/21	
Pollution Degree (DIN VDE 0110, Table 1)			2	

Table 2. QSOP Insulation Characteristics

PARAMETER	SYMBOL	CONDITIONS	VALUE	UNITS
Partial Discharge Test Voltage	V _{PR}	Method B1 = V _{IORM} × 1.875 (t = 1s, partial discharge < 5pC)	1182	V _P
Maximum Repetitive Peak Isolation Voltage	V _{IORM}	(Note 5)	630	V _P
Maximum Working Isolation Voltage	V _{IOWM}	Continuous RMS voltage (Note 5)	445	V _{RMS}
Maximum Transient Isolation Voltage	V _{IOTM}	t = 1s (Note 5)	4242	V _P
Maximum Withstand Isolation Voltage	V _{ISO}	f _{SW} = 60Hz, duration = 60s (Note 5, 6)	3000	V _{RMS}
Maximum Surge Isolation Voltage	V _{IOSM}	Basic Insulation, 1.2/50µs pulse per IEC 61000-4-5 (Note 5, 7)	7.5	kV
Insulation Resistance	R _{IO}	V _{IO} = 500V, T _A = 25°C	> 10 ¹²	Ω
		V _{IO} = 500V, 100°C ≤ T _A ≤ 125°C	> 10 ¹¹	
		V _{IO} = 500V at T _A = 150°C	> 10 ⁹	
Barrier Capacitance Side A to Side B	C _{IO}	f _{SW} = 1MHz (Note 8)	2	pF
Minimum Creepage Distance	CPG	QSOP	4	mm
Minimum Clearance Distance	CLR	QSOP	4	mm
Internal Clearance		Distance through insulation	0.015	mm
Comparative Tracking Index	CTI	Material Group II (IEC 60112)	> 400	
Climate Category			40/125/21	
Pollution Degree (DIN VDE 0110, Table 1)			2	

Note 5: V_{ISO}, V_{IOTM}, V_{IOSM}, V_{IOWM}, and V_{IORM} are defined by the IEC 60747-5-5 standard.

Note 6: Product is qualified at V_{ISO} for 60s and 100% production tested at 120% of V_{ISO} for 1s.

Note 7: Devices are immersed in oil during surge characterization.

Note 8: Capacitance is measured with all pins on field-side and logic-side tied together.

Safety Limits

Damage to the IC can result in a low-resistance path to ground or to the supply and, without current limiting, the MAX14430–MAX14432 could dissipate excessive amounts of power. Excessive power dissipation can damage the die and result in damage to the isolation barrier, potentially causing downstream issues. [Table 3](#) shows the safety limits for the MAX14430–MAX14432.

The maximum safety temperature (T_S) for the device is the 150°C maximum junction temperature specified in the [Absolute Maximum Ratings](#). The power dissipation (P_D) and junction-to-ambient thermal impedance (θ_{JA}) determine the junction temperature. Thermal impedance values (θ_{JA} and θ_{JC}) are available in the [Package Information](#) section of the datasheet and power dissipation calculations are discussed in the [Calculating Power Dissipation](#) section. Calculate the junction temperature (T_J) as:

$$T_J = T_A + (P_D \times \theta_{JA})$$

[Figure 2](#) and [Figure 3](#) show the thermal derating curves for the safety power limiting of the devices and [Figure 4](#)

shows the thermal derating curve for the safety current limiting of the devices. Ensure that the junction temperature does not exceed 150°C.

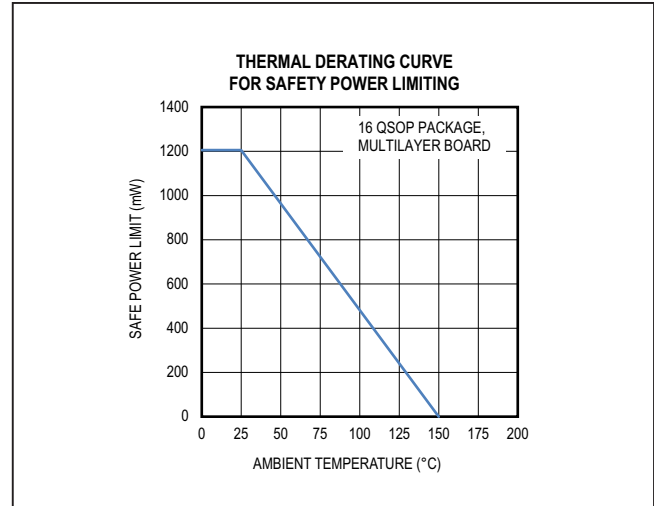

Figure 3. Thermal Derating Curve for Safety Power Limiting - QSOP

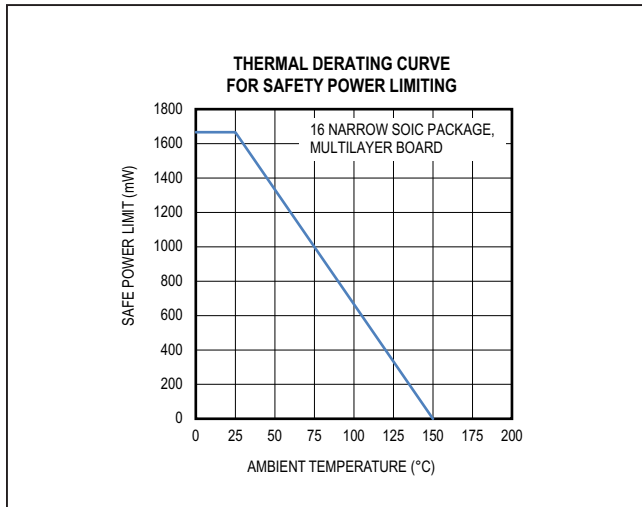

Figure 2. Thermal Derating Curve for Safety Power Limiting - Narrow SOIC

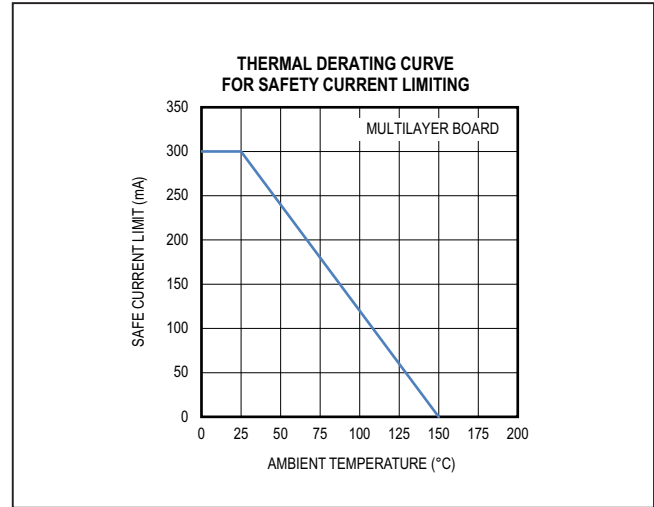

Figure 4. Thermal Derating Curve for Safety Current Limiting

Table 3. Safety Limiting Values for the MAX14430–MAX14432

PARAMETER	SYMBOL	TEST CONDITIONS	MAX	UNITS	
Safety Current on Any Pin (No Damage to Isolation Barrier)	I _S	T _J = 150°C, T _A = 25°C	300	mA	
Total Safety Power Dissipation	P _S	T _J = 150°C, T _A = 25°C	Narrow SOIC	1667	mW
			QSOP	1205	
Maximum Safety Temperature	T _S		150	°C	

Typical Operating Characteristics

(V_{DDA} - V_{GNDA} = +3.3V, V_{DDB} - V_{GNDB} = +3.3V, V_{GNDA} = V_{GNDB}, T_A = +25°C, unless otherwise noted.)

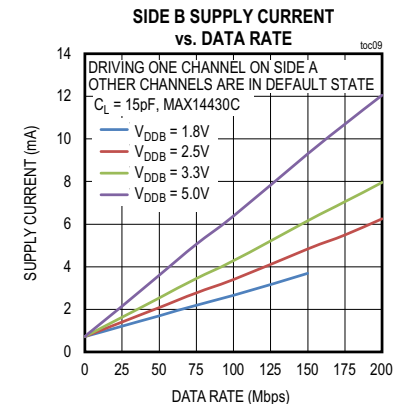
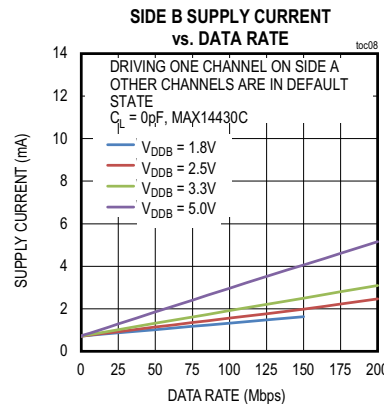
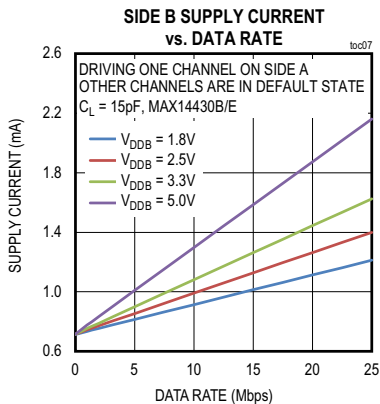
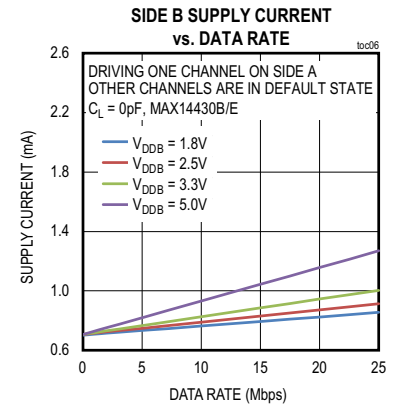
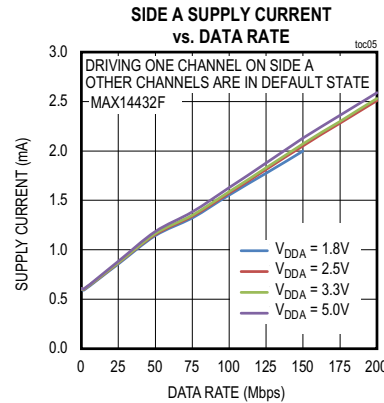
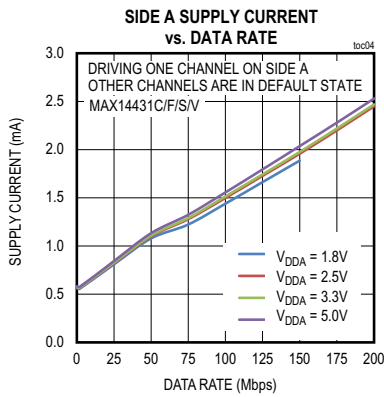
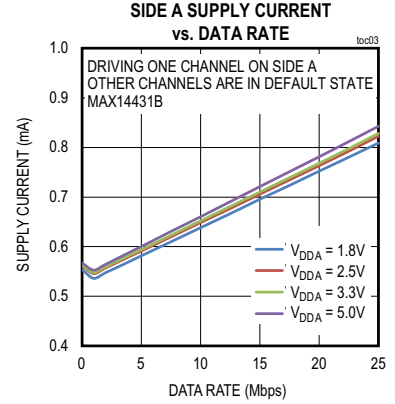
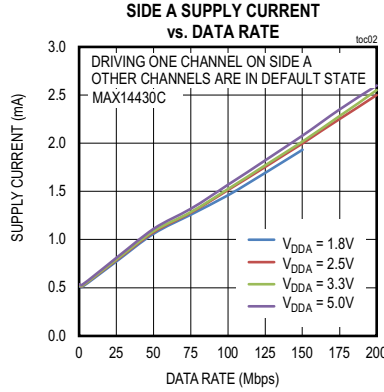
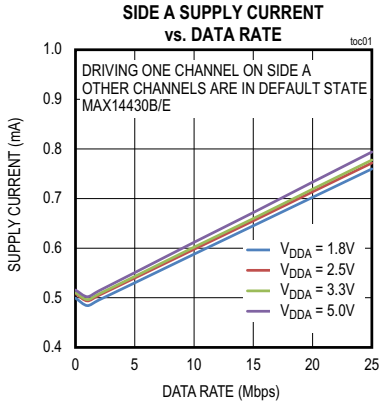

Typical Operating Characteristics (continued)

(V_{DDA} - V_{GNDA} = +3.3V, V_{DDB} - V_{GNDB} = +3.3V, V_{GNDA} = V_{GNDB}, T_A = +25°C, unless otherwise noted.)

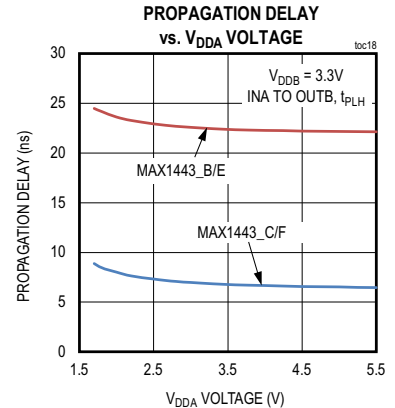
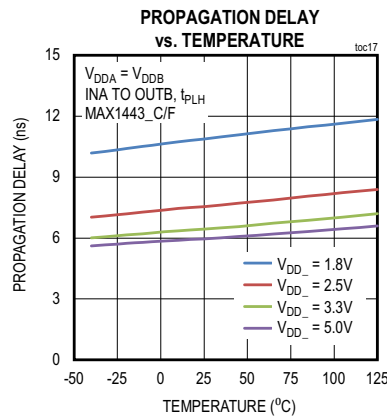
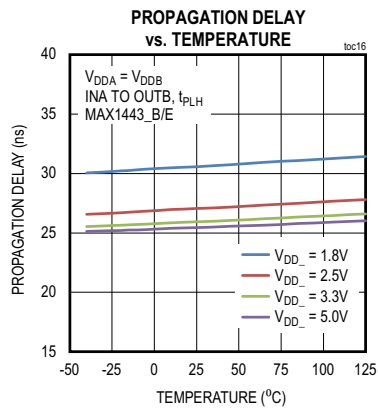
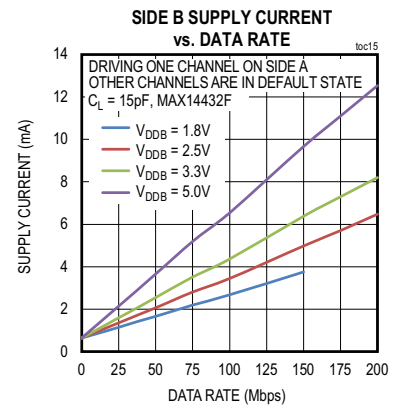
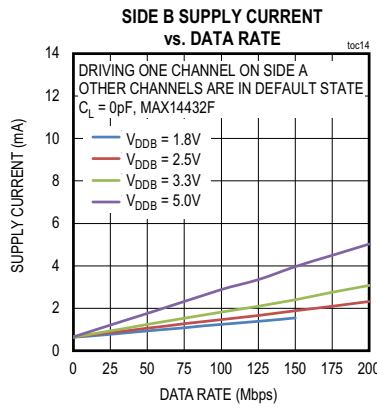
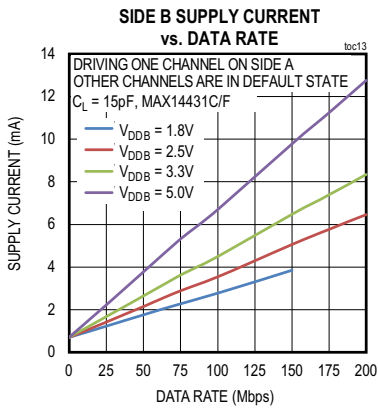
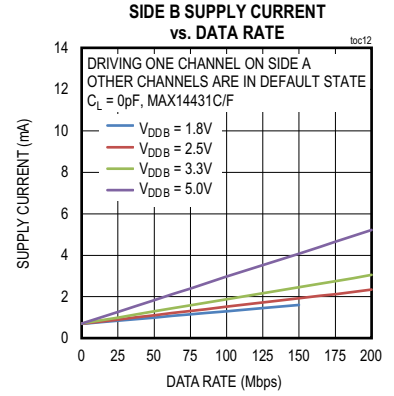
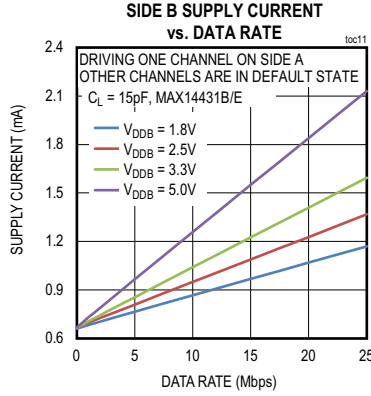
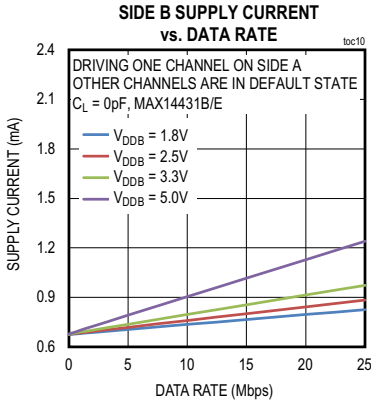

Typical Operating Characteristics (continued)

($V_{DDA} - V_{GNDA} = +3.3V$, $V_{DDB} - V_{GNDB} = +3.3V$, $V_{GNDA} = V_{GNDB}$, $T_A = +25^\circ C$, unless otherwise noted.)

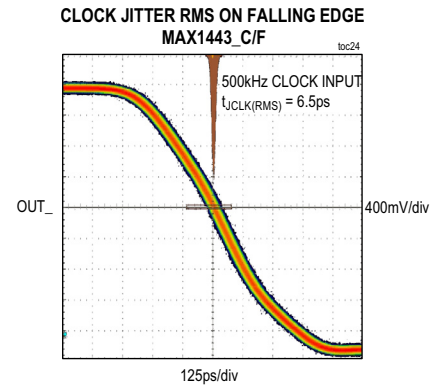
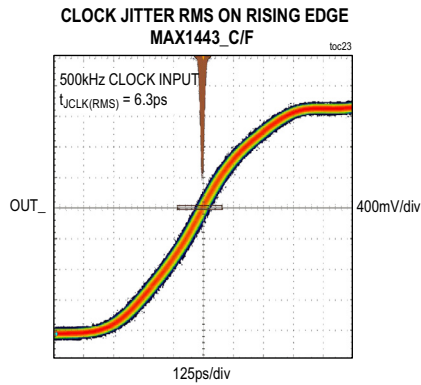
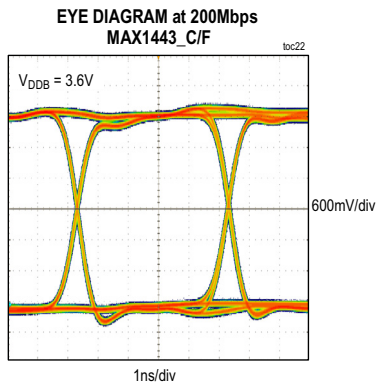
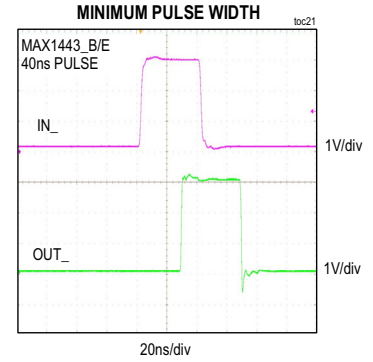
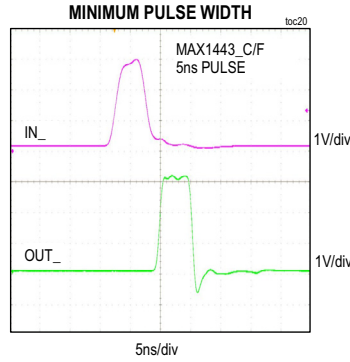
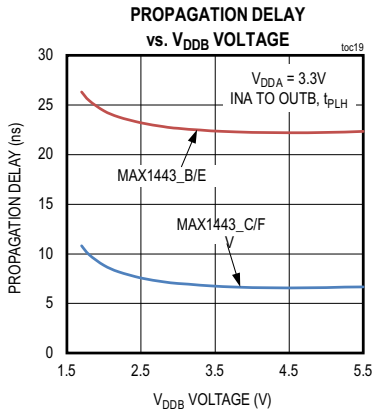

Pin Configurations

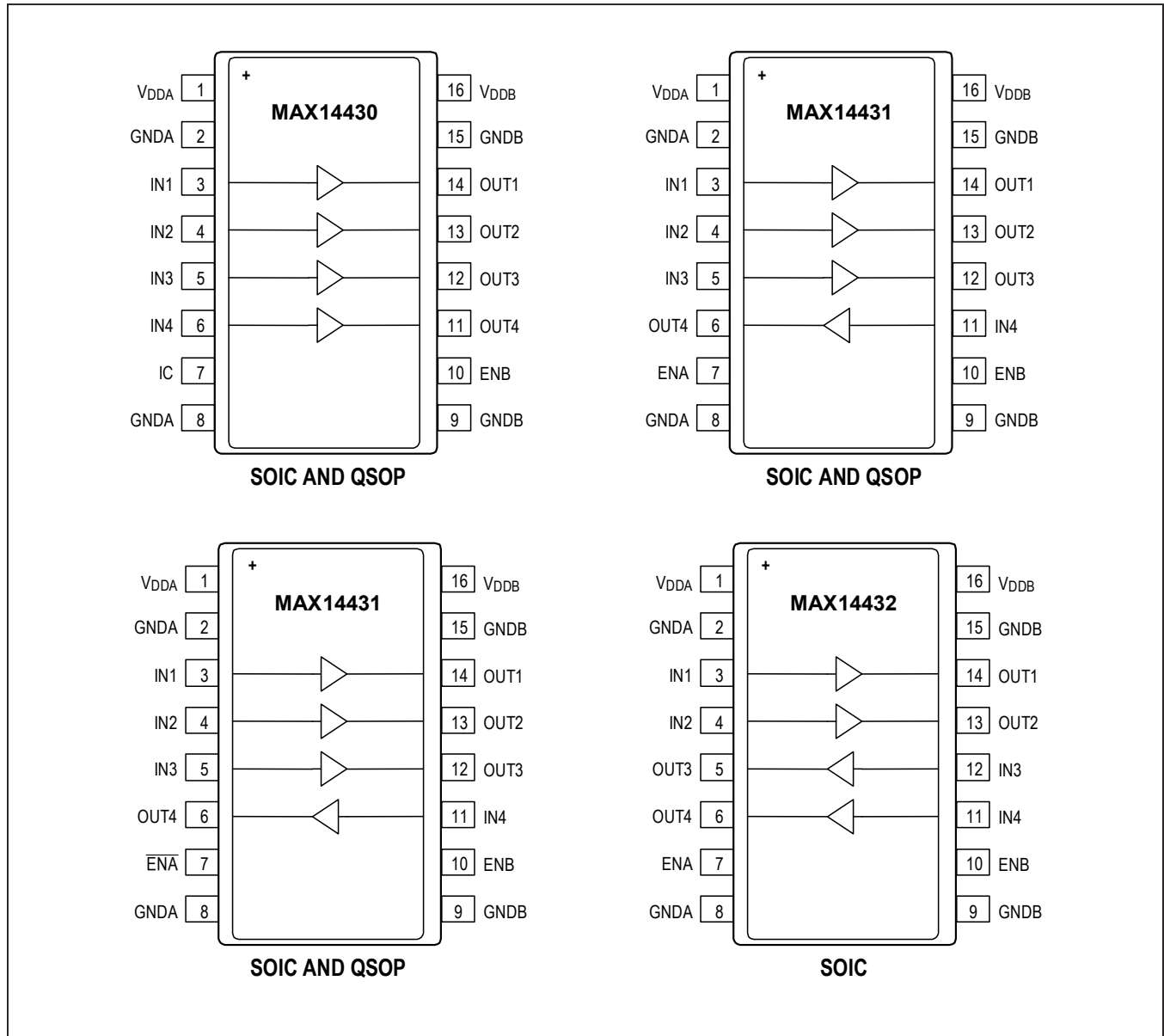

Pin Description

NAME	PIN			FUNCTION
	MAX14430	MAX14431B/C/F	MAX14432	
V _{DDA}	1	1	1	Power Supply. Bypass V _{DDA} with a 0.1µF ceramic capacitor as close as possible to the pin.
GNDA	2, 8	2, 8	2, 8	Ground Reference for Side A
IN1	3	3	3	Logic Input 1 on Side A. Corresponds to Logic Output 1 on Side B.
IN2	4	4	4	Logic Input 2 on Side A. Corresponds to Logic Output 2 on Side B.
IN3	5	5	12	Logic Input 3 on Side A or B. Corresponds to Logic Output 3 on Side B or A.
IN4	6	11	11	Logic Input 4 on Side A or B. Corresponds to Logic Output 4 on Side B or A.
I.C.	7	—	—	Internally Connected. Leave unconnected or connect to GNDA or V _{DDA} .
ENA	—	7	7	Active-High Enable for Side A. ENA has an internal 5µA pullup to V _{DDA} .
$\overline{\text{ENA}}$	—	—	—	Active-Low Enable for Side A. $\overline{\text{ENA}}$ has an internal 5µA pullup to V _{DDA} .
OUT1	14	14	14	Logic Output 1 on Side B
OUT2	13	13	13	Logic Output 2 on Side B
OUT3	12	12	5	Logic Output 3 on Side A or Side B
OUT4	11	6	6	Logic Output 4 on Side A or Side B
ENB	10	10	10	Active-High Enable for Side B. ENB has an internal 5µA pullup to V _{DDB} .
GNDB	9, 15	9, 15	9, 15	Ground Reference for Side B
V _{DDB}	16	16	16	Power Supply. Bypass V _{DDB} with a 0.1µF ceramic capacitor as close as possible to the pin.

Functional Diagram

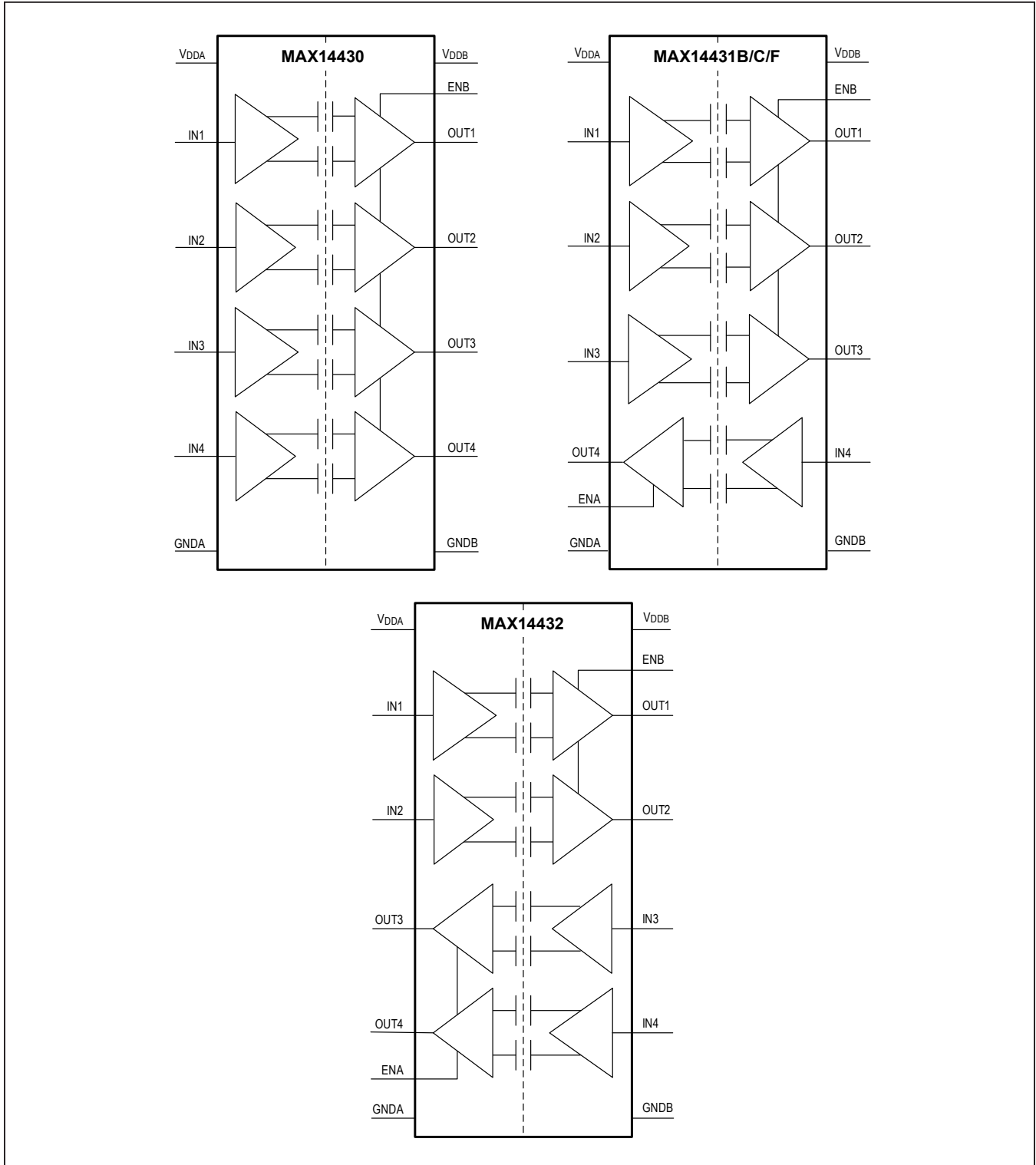

Detailed Description

The MAX14430–MAX14432 are a family of 4-channel digital isolators. The MAX14430–MAX14432 have an isolation rating of 3kV_{RMS} (QSOP package) or 3.75kV_{RMS} (narrow SOIC package) for 60 seconds. The MAX14430–MAX14432 family offers all three possible unidirectional channel configurations to accommodate any 4-channel design, including SPI, RS-232, RS-485, and digital I/O applications. For applications requiring bidirectional channels, such as I²C, see the MAX14933 and MAX14937.

The MAX14430 features four channels transferring digital signals in one direction for applications such as isolated digital I/O. The MAX14431 has three channels transmitting data in one direction and one channel transmitting in the opposite direction, making it ideal for applications such as isolated SPI and RS-485 communication. The MAX14432 provides further design flexibility with two channels in each direction for isolated RS-232 or other applications.

Devices are available either in the 16-pin narrow-body SOIC package and are rated for up to 3.75kV_{RMS}, or in the 16-pin QSOP package and are rated for up to 3kV_{RMS}. This family of digital isolators offers low-power operation, high electromagnetic interference (EMI) immunity, and stable temperature performance through Maxim's proprietary process technology. The devices isolate different ground domains and block high-voltage/high-current transients from sensitive or human interface circuitry.

Devices are available with a maximum data rate of either 25Mbps (B/E/R/U versions) or 200Mbps (C/F/S/V versions). Each device can be ordered with default-high or default-low outputs. The default is the state the output assumes when the input is not powered or if the input is open circuit. The devices have two supply inputs (V_{DDA} and V_{DDB}) that independently set the logic levels on either side of

the device. V_{DDA} and V_{DDB} are referenced to GNDA and GNDB, respectively. The MAX14430–MAX14432 family also features a refresh circuit to ensure output accuracy when an input remains in the same state indefinitely.

Digital Isolation

The MAX14430–MAX14432 family provides galvanic isolation for digital signals that are transmitted between two ground domains. Two isolation ratings are available in two different package options. The devices in the narrow-body SOIC package withstand differences of up to 3.75kV_{RMS} for up to 60 seconds, and up to 630V_{PEAK} of continuous isolation. The devices in the QSOP package withstand differences of up to 3kV_{RMS} for up to 60 seconds, and up to 630V_{PEAK} of continuous isolation. See the [Ordering Information](#) and [Product Selector Guide](#) for suffixes associated with each option.

Level-Shifting

The wide supply voltage range of both V_{DDA} and V_{DDB} allows the MAX14430–MAX14432 family to be used for level translation in addition to isolation. V_{DDA} and V_{DDB} can be independently set to any voltage from 1.71V to 5.5V. The supply voltage sets the logic level on the corresponding side of the isolator.

Unidirectional Channels

Each channel of the MAX14430–MAX14432 is unidirectional; it only passes data in one direction, as indicated in the functional diagram. Each device features four unidirectional channels that operate independently with guaranteed data rates from DC up to 25Mbps (B/E versions), or from DC to 200Mbps (C/F versions). The output driver of each channel is push-pull, eliminating the need for pullup resistors. The outputs are able to drive both TTL and CMOS logic inputs.

Startup and Undervoltage-Lockout

The V_{DDA} and V_{DDB} supplies are both internally monitored for undervoltage conditions. Undervoltage events can occur during power-up, power-down, or during normal operation due to a sagging supply voltage. When an undervoltage

condition is detected on either supply while the outputs are enabled, all outputs go to their default states regardless of the state of the inputs (Table 4). Figure 5 through Figure 9 show the behavior of the outputs during power-up and power-down.

Table 4. MAX1443_B/C/E/F Output Behavior During Undervoltage Conditions

V _{IN_}	V _{DDA}	V _{DDB}	ENA	ENB	V _{OUTA}	V _{OUTB}
1	Powered	Powered	1	1	1	1
			0	0	Hi-Z	Hi-Z
0	Powered	Powered	1	1	0	0
			0	0	Hi-Z	Hi-Z
X	Undervoltage	Powered	1	1	Default	Default
			0	0	Hi-Z	Hi-Z
X	Powered	Undervoltage	1	1	Default	Default
			0	0	Hi-Z	Hi-Z

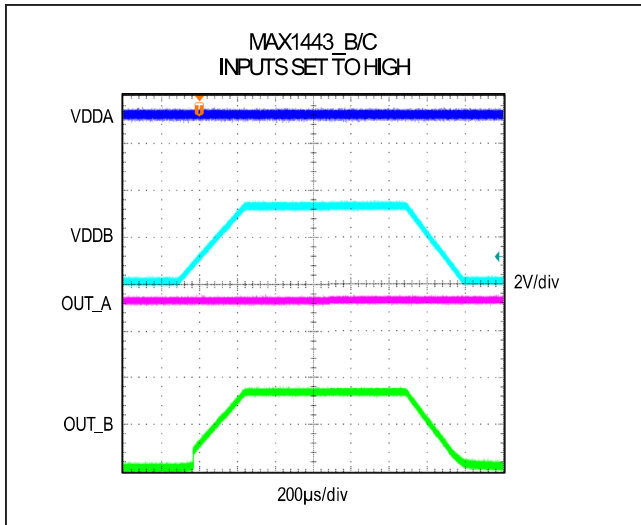

Figure 5. Undervoltage Lockout Behavior (MAX1443_B/C High)

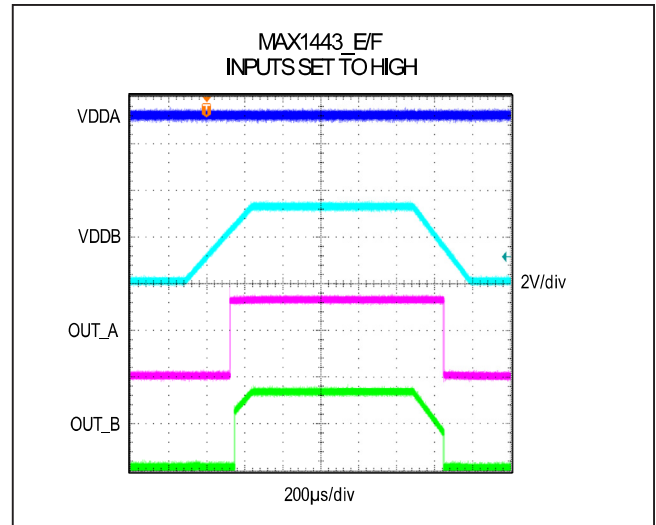

Figure 6. Undervoltage Lockout Behavior (MAX1443_E/F High)

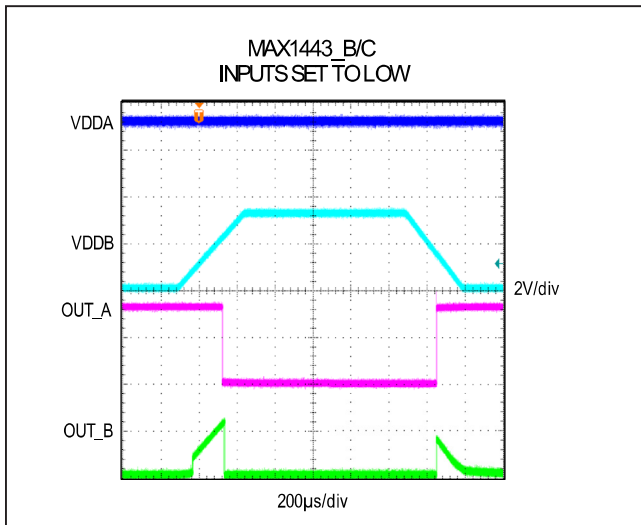

Figure 7. Undervoltage Lockout Behavior (MAX1443_B/C Low)

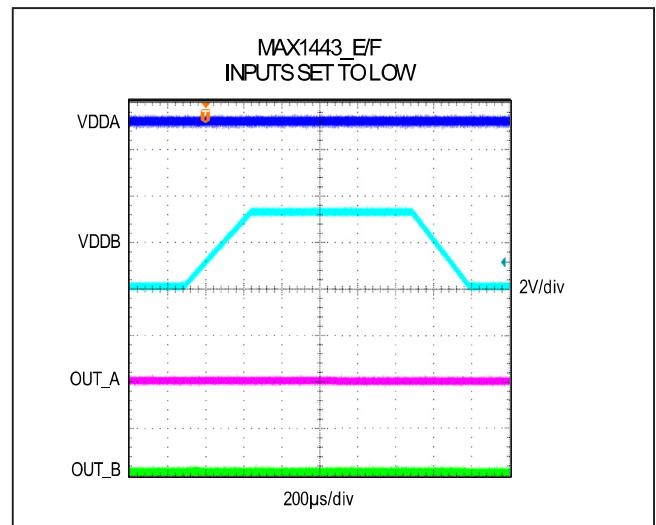

Figure 8. Undervoltage Lockout Behavior (MAX1443_E/F Low)

Applications Information

Power-Supply Sequencing

The MAX14430–MAX14432 do not require special power supply sequencing. The logic levels are set independently on either side by V_{DDA} and V_{DDB}. Each supply can be present over the entire specified range regardless of the level or presence of the other supply.

Power-Supply Decoupling

To reduce ripple and the chance of introducing data errors, bypass V_{DDA} and V_{DDB} with 0.1µF low-ESR ceramic capacitors to GNDA and GNDB, respectively. Place the bypass capacitors as close to the power supply input pins as possible.

Layout Considerations

The PCB designer should follow some critical recommendations in order to get the best performance from the design.

- Keep the input/output traces as short as possible. To keep signal paths low-inductance, avoid using vias.
- Have a solid ground plane underneath the high-speed signal layer.
- Keep the area underneath the MAX14430–MAX14432 free from ground and signal planes. Any galvanic or metallic connection between the field-side and logic-side defeats the isolation.

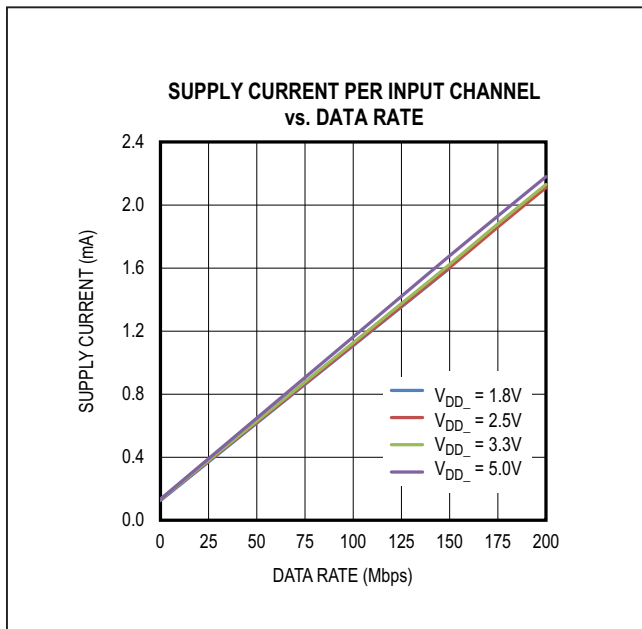

Figure 9. Supply Current Per Input Channel (Estimated)

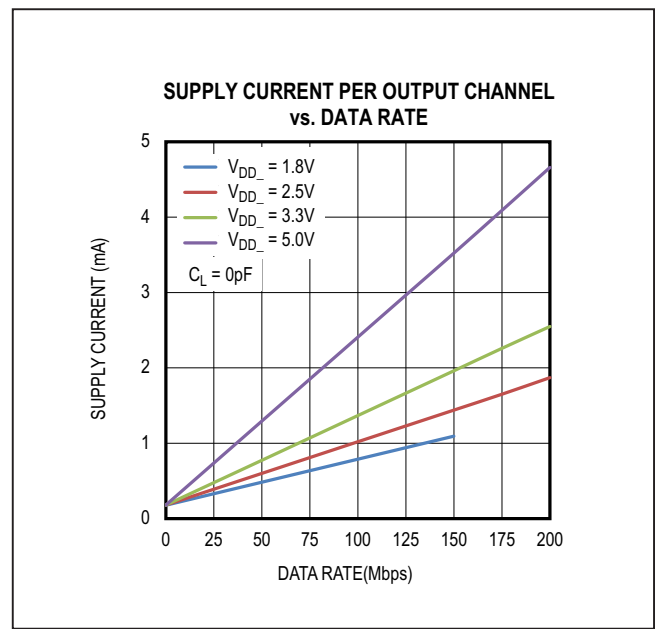

Figure 10. Supply Current Per Output Channel (Estimated)

Calculating Power Dissipation

The required current for a given supply (V_{DDA} or V_{DDB}) can be estimated by summing the current required for each channel. The supply current for a channel depends on whether the channel is an input or an output, the channel's data rate, and the capacitive or resistive load if it is an output. The typical current for an input or output at any data rate can be estimated from the graphs in [Figure 9](#) and [Figure 10](#). Please note the data in [Figure 9](#) and [Figure 10](#) are extrapolated from the supply current measurements in a typical operating condition.

The total current for a single channel is the sum of the “no load” current (shown in [Figure 9](#) and [Figure 10](#)) which is a function of Voltage and Data Rate, and the “load current,” which depends on the type of load. Current into a capacitive load is a function of the load capacitance, the switching frequency, and the supply voltage.

$$I_{CL} = C_L \times f_{SW} \times V_{DD}$$

where

I_{CL} is the current required to drive the capacitive load.

C_L is the load capacitance on the isolator's output pin.

f_{SW} is the switching frequency (bits per second/2).

V_{DD} is the supply voltage on the output side of the isolator.

Current into a resistive load depends on the load resistance, the supply voltage and the average duty cycle of the data waveform. The DC load current can be conservatively estimated by assuming the output is always high.

$$I_{RL} = V_{DD} \div R_L$$

where

I_{RL} is the current required to drive the resistive load.

V_{DD} is the supply voltage on the output side of the isolator.

R_L is the load resistance on the isolator's output pin.

Example (shown in [Figure 11](#)): A MAX14431F is operating with V_{DDA} = 2.5V, V_{DDB} = 3.3V, channel 1 operating at 20Mbps with a 10pF capacitive load, channel 2 held high with a 10kΩ resistive load, and channel 4 operating at 100Mbps with a 15pF capacitive load. Channel 3 is not in use and the resistive load is negligible since the isolator is driving a CMOS input. Refer to [Table 5](#) and [Table 6](#) for V_{DDA} and V_{DDB} supply current calculation worksheets.

V_{DDA} must supply:

- Channel 1 is an input channel operating at 2.5V and 20Mbps, consuming 0.33mA, estimated from [Figure 9](#).
- Channel 2 and 3 are input channels operating at 2.5V with DC signal, consuming 0.13mA, estimated from [Figure 9](#).
- Channel 4 is an output channel operating at 2.5V and 100Mbps, consuming 1.02mA, estimated from [Figure 10](#).
- I_{CL} on channel 4 for 15pF capacitor at 2.5V and 100Mbps is 1.875mA.

Total current for side A = 0.33 + 0.13 × 2 + 1.02 + 1.875 = 3.485mA, typical

V_{DDB} must supply:

- Channel 1 is an output channel operating at 3.3V and 20Mbps, consuming 0.42mA, estimated from [Figure 10](#).
- Channel 2 and 3 are output channels operating at 3.3V with DC signal, consuming 0.18mA, estimated from [Figure 10](#).
- Channel 4 is an input channel operating at 3.3V and 100Mbps, consuming 1.13mA, estimated from [Figure 9](#).
- I_{CL} on channel 1 for 10pF capacitor at 3.3V and 20Mbps is 0.33mA.
- I_{RL} on channel 2 for 10kΩ resistor held at 3.3V is 0.33mA.

Total current for side B = 0.42 + 0.18 × 2 + 1.13 + 0.33 + 0.33 = 2.57mA, typical

Table 5. Side A Supply Current Calculation Worksheet

SIDE A		V _{DDA} = 2.5V				
Channel	IN/OUT	Data Rate (Mbps)	Load Type	Load	“No Load” Current (mA)	Load Current (mA)
1	IN	20			0.33	
2	IN	0			0.13	
3	IN	0			0.13	
4	OUT	100	Capacitive	15pF	1.02	2.5V x 50MHz x 15pF = 1.875mA
Total: 3.485mA						

Table 6. Side B Supply Current Calculation Worksheet

SIDE B	V _{DDB} = 3.3V					
Channel	IN/OUT	Data Rate (Mbps)	Load Type	Load	“No Load” Current (mA)	Load Current (mA)
1	OUT	20	Capacitive	10pF	0.42	3.3V x 10MHz x 10pF = 0.33mA
2	OUT	0	Resistive	10kΩ	0.18	3.3V / 10kΩ = 0.33mA
3	OUT	0			0.18	
4	IN	100			1.13	
Total: 2.57mA						

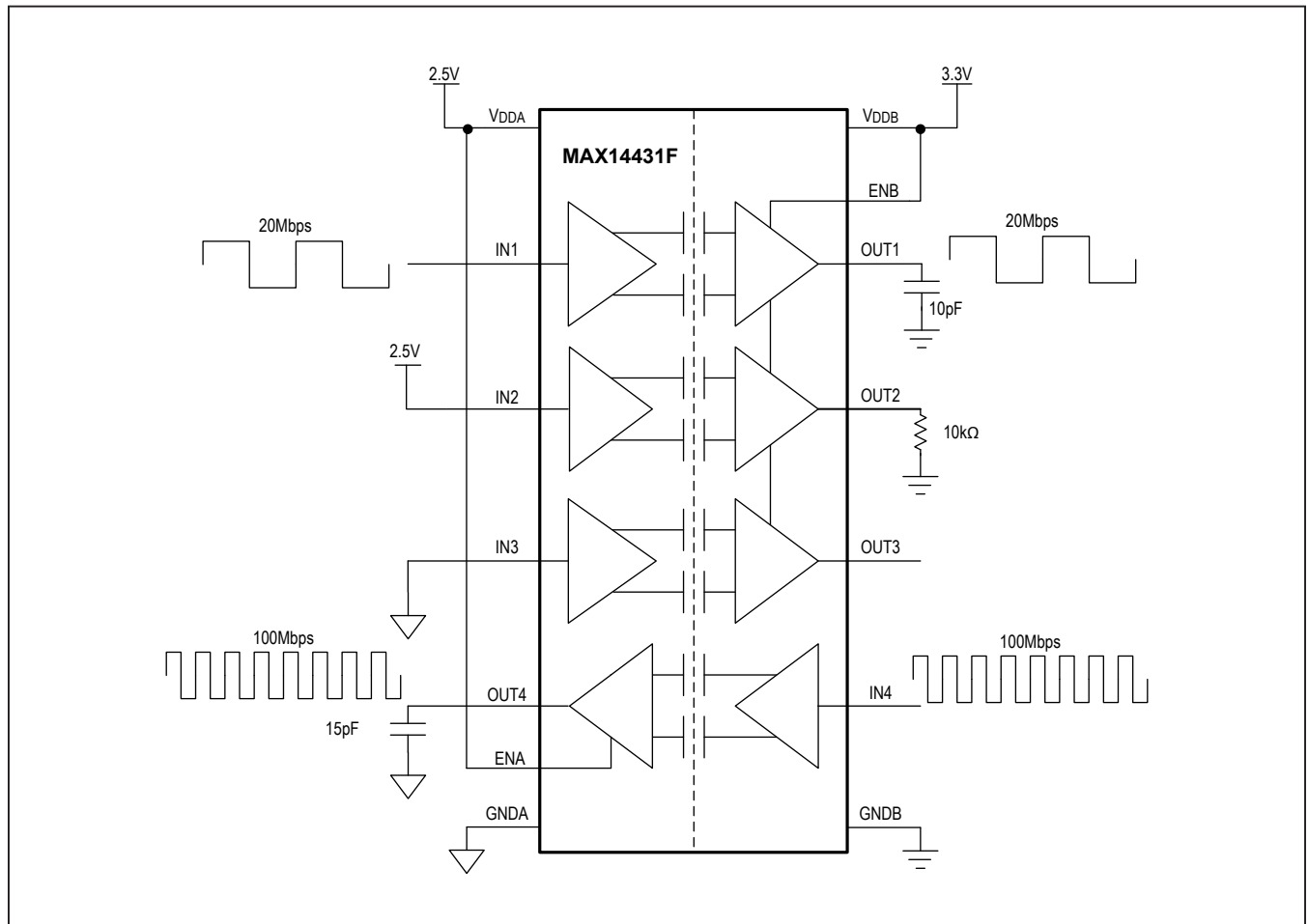
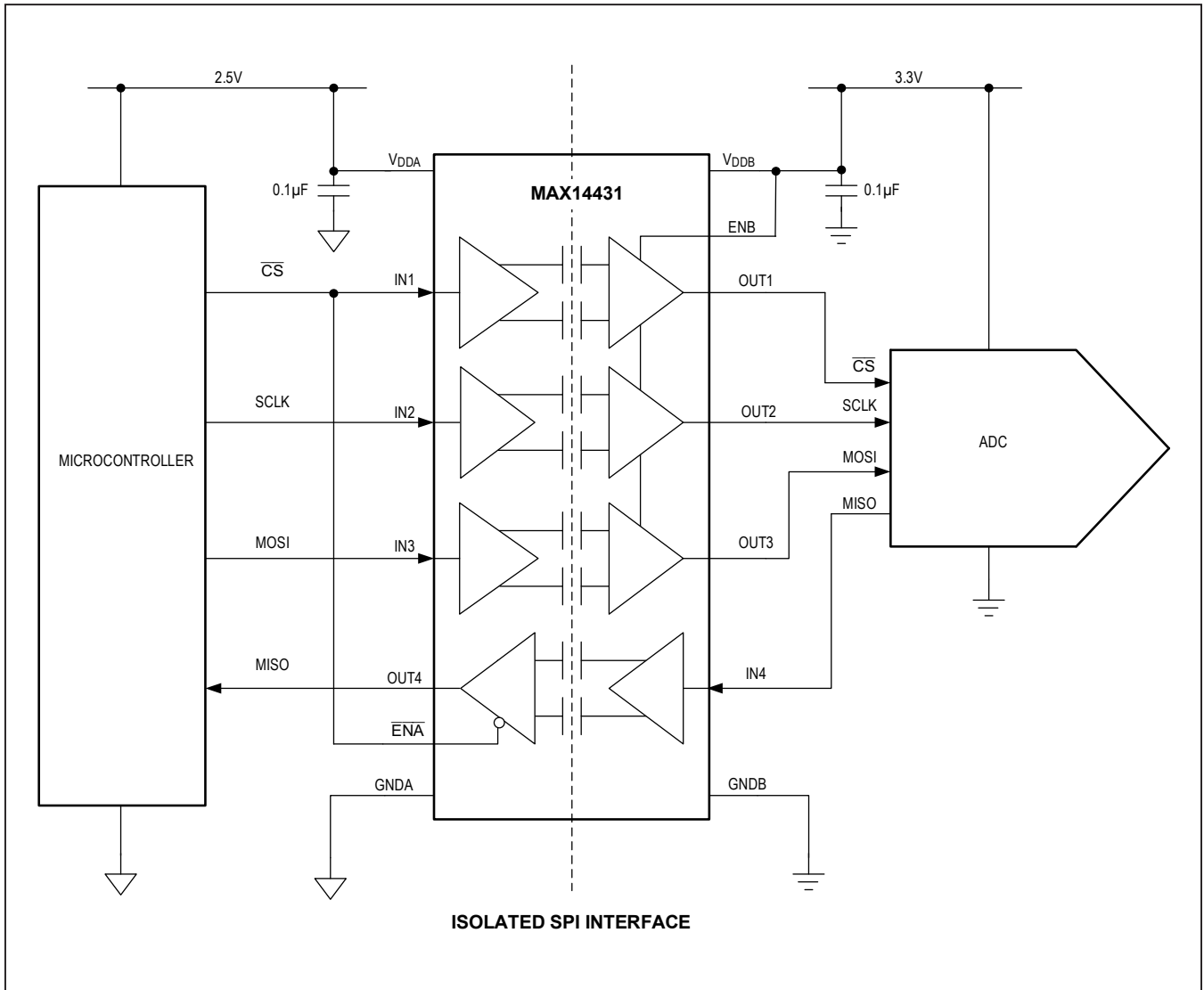
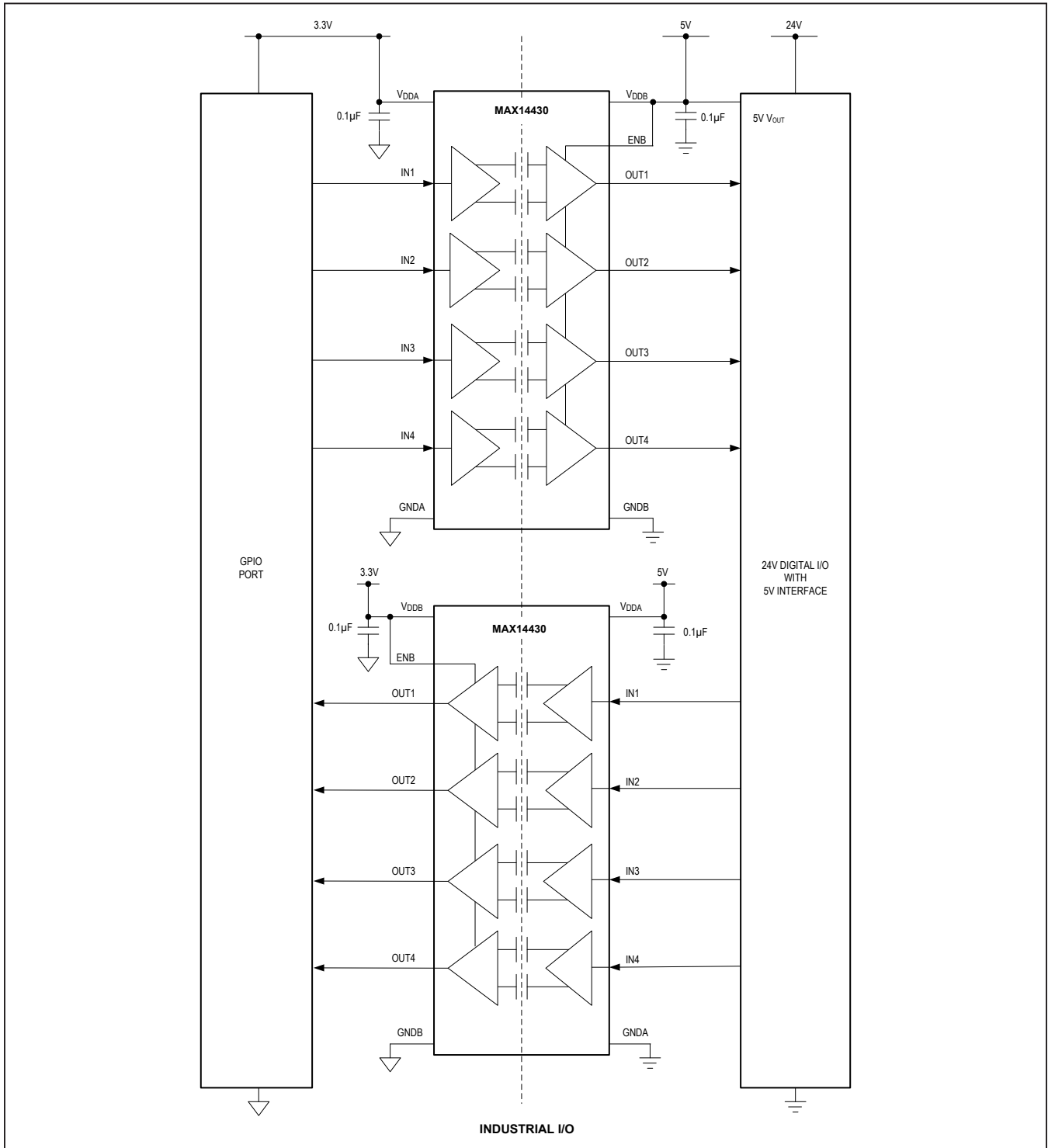

Figure 11. Example Circuit for Supply Current Calculation

Typical Application Circuits



Typical Application Circuits (continued)



Typical Application Circuits (continued)

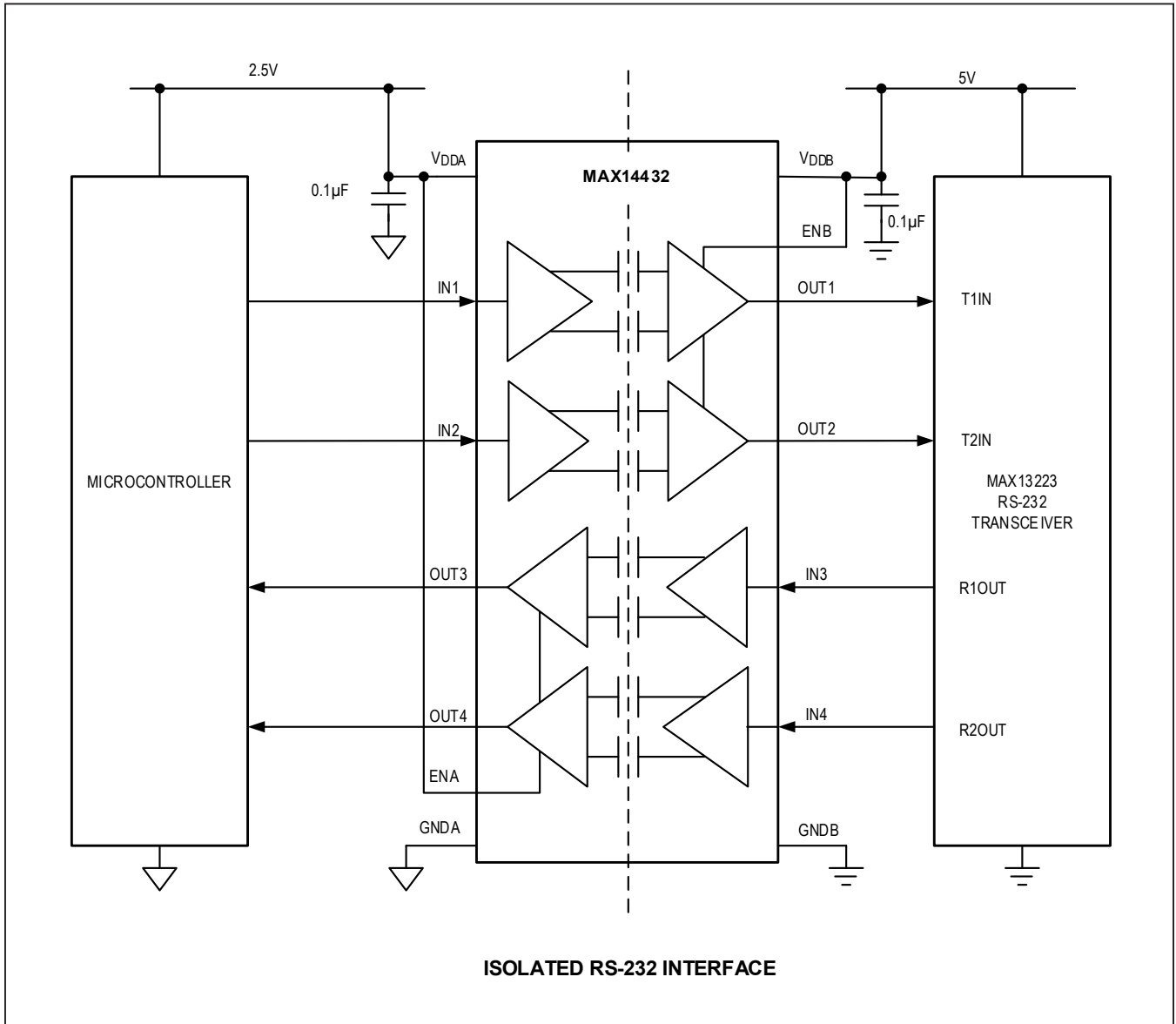

MAX14430–MAX14432

Four-Channel, Fast, Low-Power, 3kV_{RMS} and 3.75kV_{RMS} Digital Isolators

Product Selector Guide

DEVICE CONFIGURATION	ACTIVE-HIGH ENA		ACTIVE-LOW $\overline{\text{EN}}\text{A}$	
	MAX DATA RATE		MAX DATA RATE	
	25Mbps	200Mbps	25Mbps	200Mbps
DEFAULT-HIGH OUTPUT	B	C	R	S
DEFAULT-LOW OUTPUT	E	F	U	V

Ordering Information

PART	CHANNEL CONFIGURATION	DATA RATE (Mbps)	DEFAULT OUTPUT	ENA Polarity	ISOLATION VOLTAGE (kV _{RMS})	TEMP RANGE (°C)	PIN-PACKAGE
MAX14430BAEE+	4/0	25	Default High	Active-High	3	-40 to +125	16 QSOP
MAX14430CASE+	4/0	200	Default High	Active-High	3.75	-40 to +125	16 Narrow SOIC
MAX14430EAAE+	4/0	25	Default Low	Active-High	3	-40 to +125	16 QSOP
MAX14431BAEE+	3/1	25	Default High	Active-High	3	-40 to +125	16 QSOP
MAX14431CAEE+	3/1	200	Default High	Active-High	3	-40 to +125	16 QSOP
MAX14431FASE+	3/1	200	Default Low	Active-High	3.75	-40 to +125	16 Narrow SOIC
MAX14432FASE+	2/2	200	Default Low	Active-High	3.75	-40 to +125	16 Narrow SOIC

+Denotes a lead(Pb)-free/RoHS-compliant package.

Chip Information

PROCESS: BiCMOS

Revision History

REVISION NUMBER	REVISION DATE	DESCRIPTION	PAGES CHANGED
0	11/17	Initial release	—
1	11/17	Updated <i>Benefits and Features</i> section, <i>Electrical Characteristics</i> table, <i>Typical Operating Characteristics</i> section, Table 3, and <i>Typical Operating Circuit</i>	1, 5, 6, 9, 11, 12,
2	3/19	Updated <i>General Description</i> , <i>Benefits and Features</i> , <i>Absolute Maximum Ratings</i> , <i>Electrical Characteristics</i> , <i>Safety Regulatory Approvals</i> , <i>Detailed Description</i> , and <i>Digital Isolation</i> sections; renumbered <i>Electrical Characteristics</i> notes; added Table 2 and renumbered subsequent tables; replaced the <i>Pin Configuration</i> and <i>Functional Diagram</i>	1–2, 6, 8–10, 14, 16–17, 25
3	7/19	Updated the <i>Safety and Regulatory Approvals</i> table and Table 2	11–12
4	7/20	Removed future product designation from MAX14431CAEE+ in the <i>Ordering Information</i> table	28
5	11/20	Updated the <i>General Description</i> , <i>Dynamic Characteristics MAX1443_C/F/S/V</i> , <i>Dynamic Characteristics MAX1443_B/E/R/U</i> , <i>Detailed Description</i> , <i>Layout Considerations</i> , <i>Typical Operating Circuits</i> , and <i>Product Selector Guide</i> sections; added the <i>Safety Limits</i> section; added new Table 3 and renumbered subsequent figures; added new Figures 2–4 and renumbered subsequent figures; replaced TOC02, TOC04, TOC06, TOC09, TOC10, TOC13–TOC14, and TOC17–TOC18; replaced Figures 9–10	1, 8, 10, 13, 19, 22, 25–28
6	8/21	Updated <i>General Description</i> section, Table 2, and <i>Ordering Information</i> table	1, 13, 30
7	12/25	Updated <i>General Description</i> , <i>DC Electrical Characteristics</i> , <i>Dynamic Characteristics MAX1443_C/F</i> , and <i>Dynamic Characteristics MAX1443_B/E</i> table, <i>Typical Operating Characteristics</i> , <i>Pin Configurations</i> , <i>Pin Description</i> , <i>Functional Diagram</i> , <i>Detailed Description</i> , <i>Typical Application Circuits</i> , and <i>Ordering Information</i> table	1, 6–10, 15–23, 27, 30
8	1/26	Removed future product designation from MAX14431BAEE+ in the <i>Ordering Information</i> table	30



Information furnished by Analog Devices is believed to be accurate and reliable. However, no responsibility is assumed by Analog Devices for its use, nor for any infringements of patents or other rights of third parties that may result from its use. Specifications subject to change without notice. No license is granted by implication or otherwise under any patent or patent rights of Analog Devices. Trademarks and registered trademarks are the property of their respective owners.